

Innenansicht
View from the Inside

- ① erstöffnend / primary panel
- ② zweitöffnend / secondary panel

I - 3R

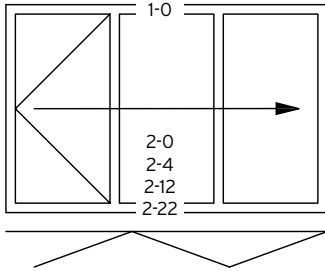

I - 3L3R

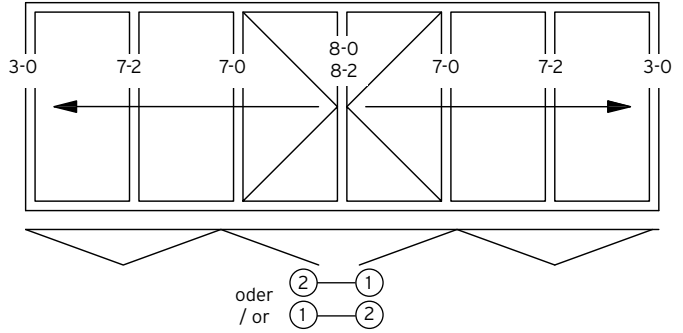

I - 2L1R

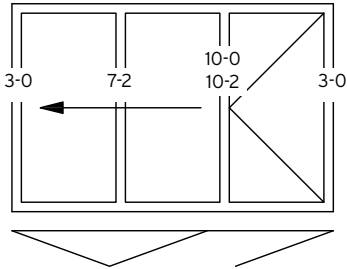

I - 5R

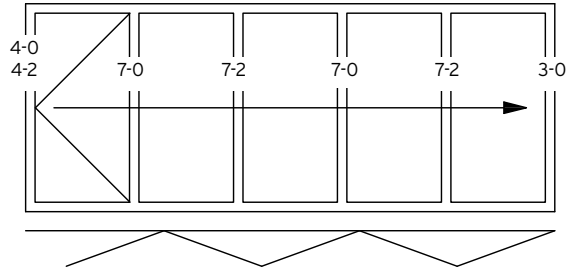

I - 4R

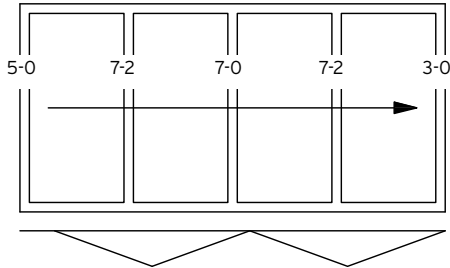

I - 2L3R

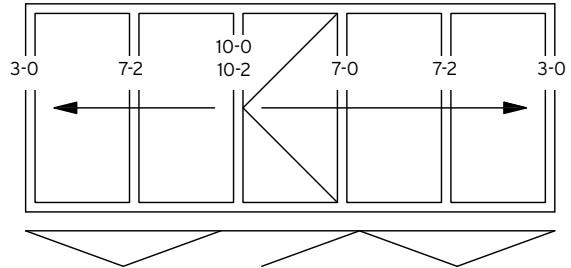

I - 2L2R

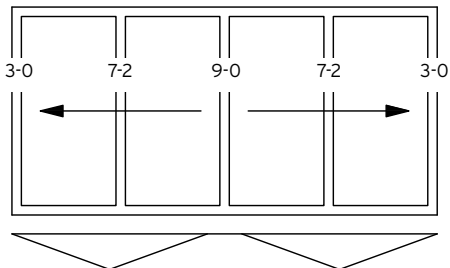

I - 1L3R

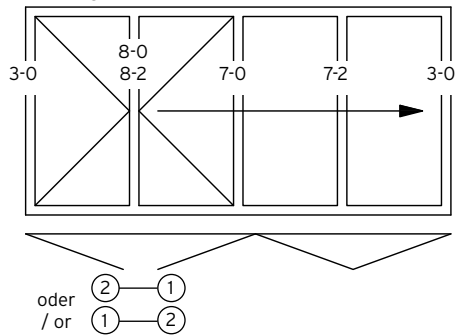

Innenansicht
View from the Inside

- ① erstöffnend / primary panel
- ② zweitöffnend / secondary panel

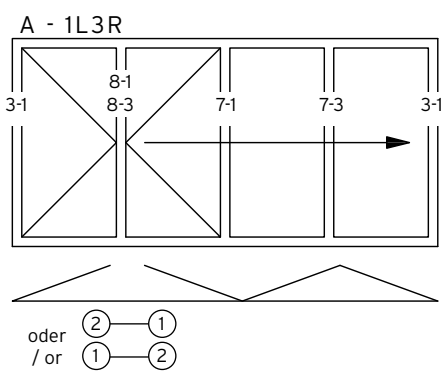
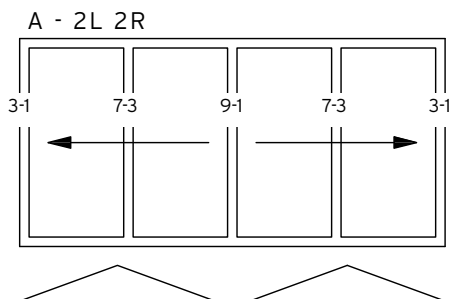
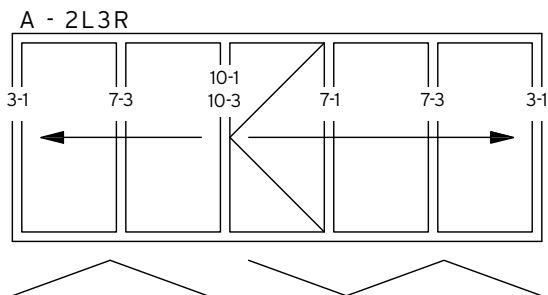
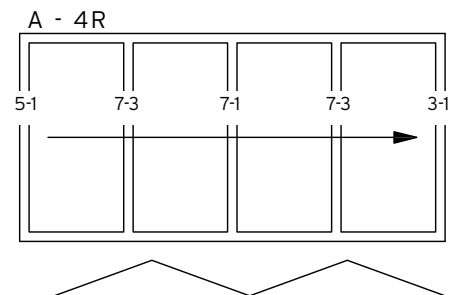
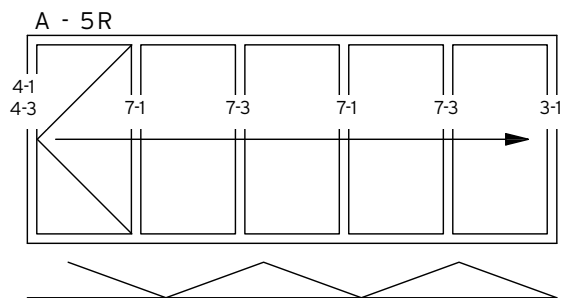
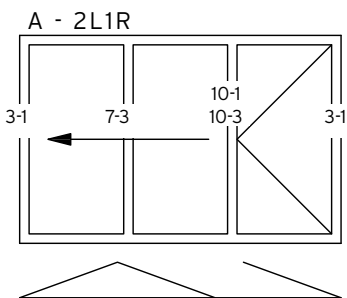
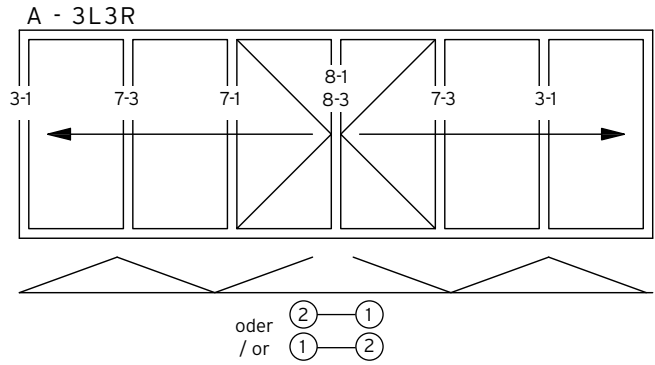
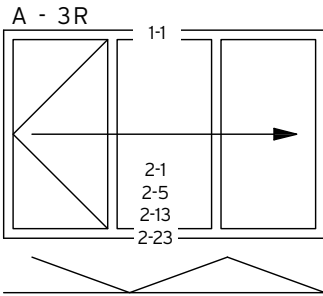

Innenansicht
View from the Inside

Faltwand mit Sprosse
 Folding façade with transom

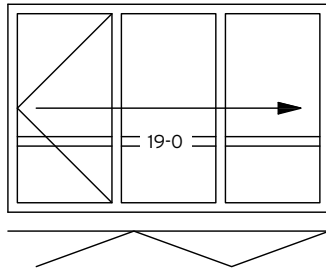

Faltwand mit Oberlicht
 Folding façade with overhead panel

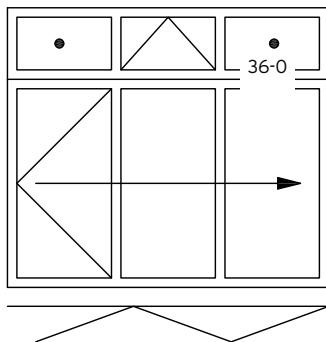

Grundrissbeispiele:
 Bei einer abgewinkelten Faltwand wird die Ausführung funktionsbedingt der Einbausituation angepasst.

Floor plan examples:
 In the case of an angled configuration the design is adapted to the situation and functional requirements.

